

DESCRIPTION	REVISIONS	DATE

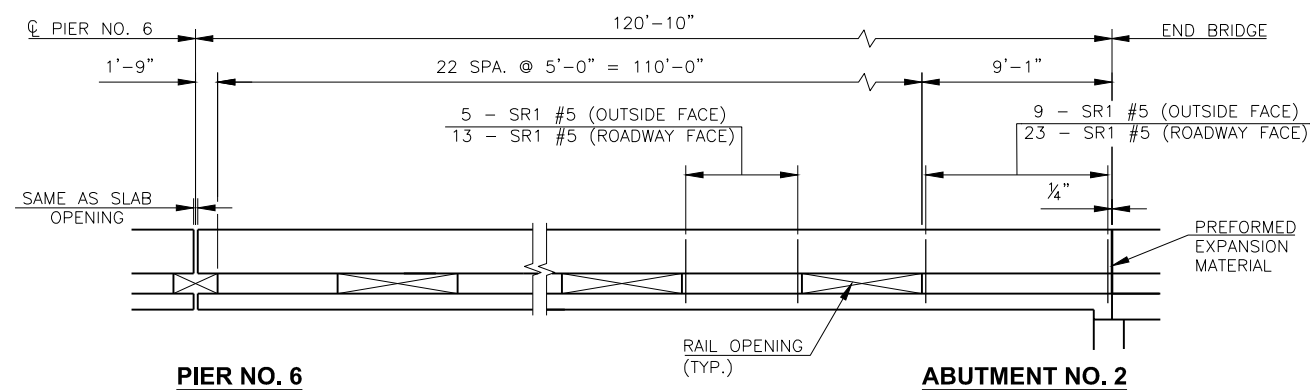
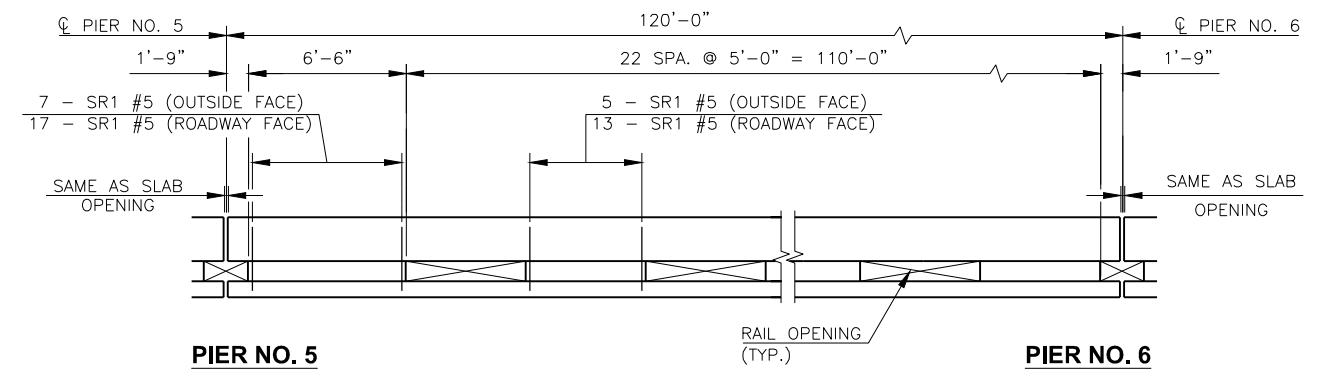
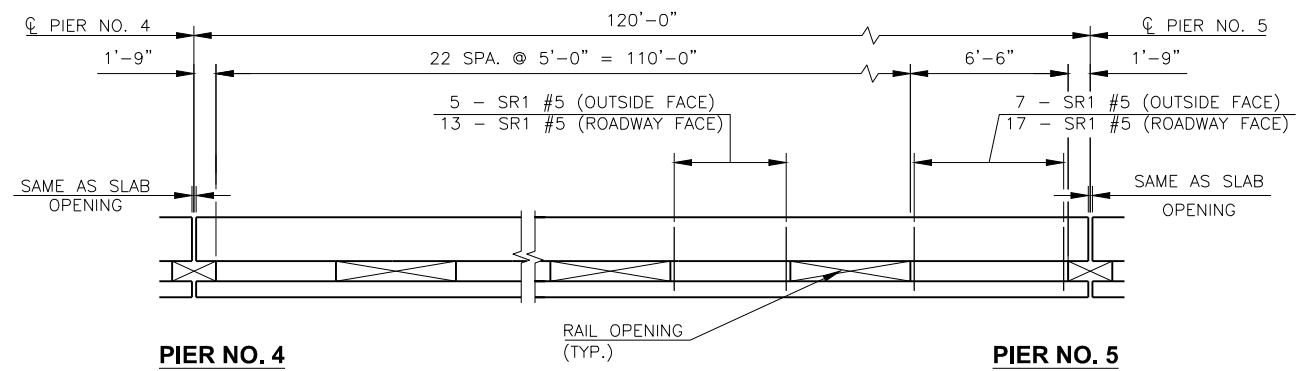
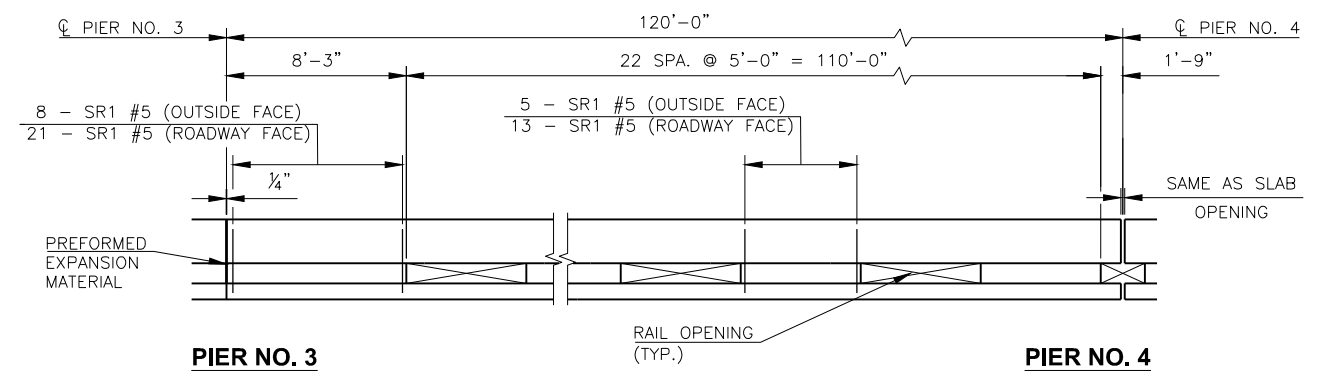
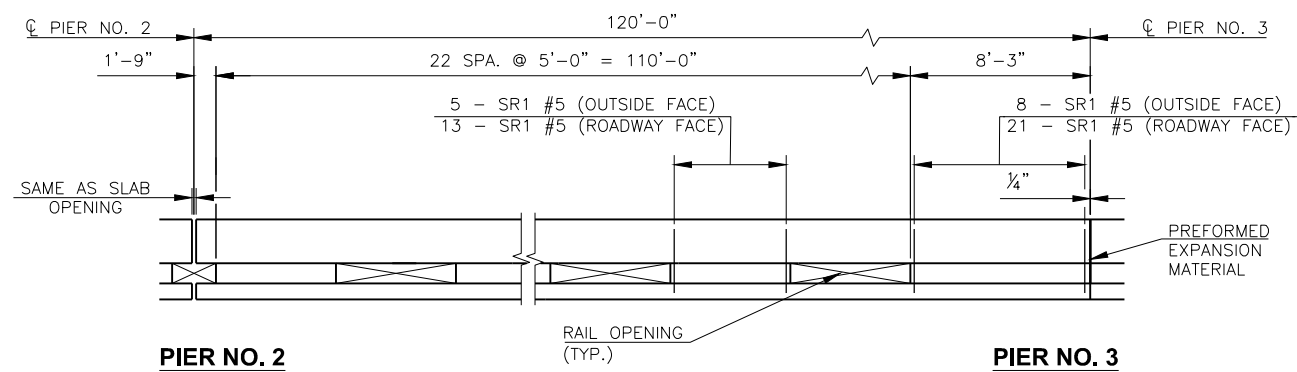
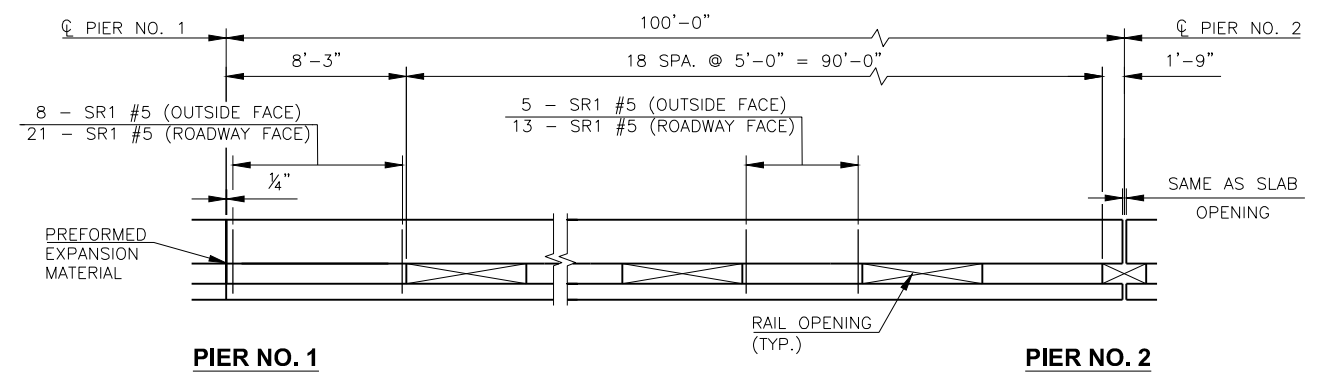
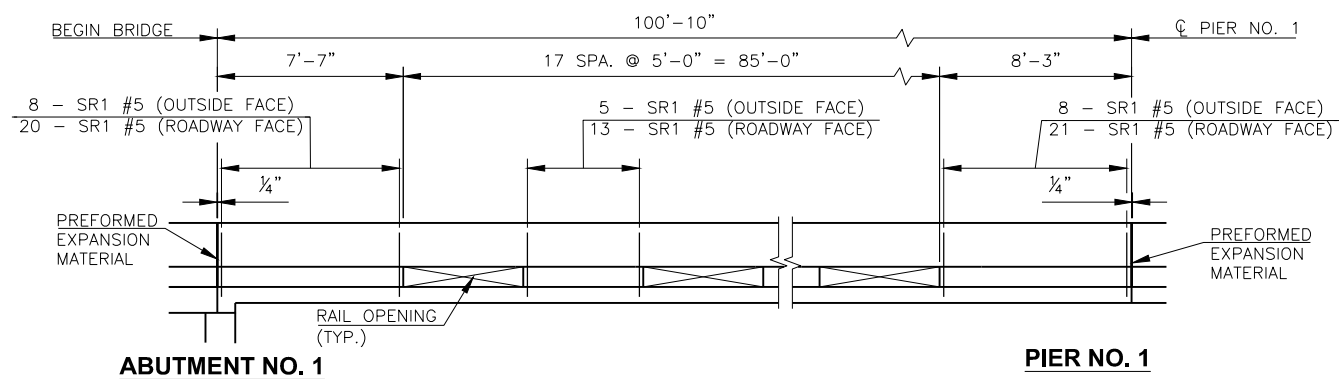

NOTE:
FOR ADDITIONAL DETAIL OF PARAPET,
SEE STD. TR4-2.

PARAPET ELEVATION

DESIGN	B.J.K.	SH-48 OVER CIMARRON RIVER	CREEK COUNTY
DRAWN	B.M.S.	PARAPET ELEVATION	
CHECKED	M.R.S.		
APPROV.	B.J.K.		
SQUAD	CEC		
		JOB PIECE NO. 27925(04)	SHEET NO. 57